



# Technical Data



Specification & Capacities

## JVL450

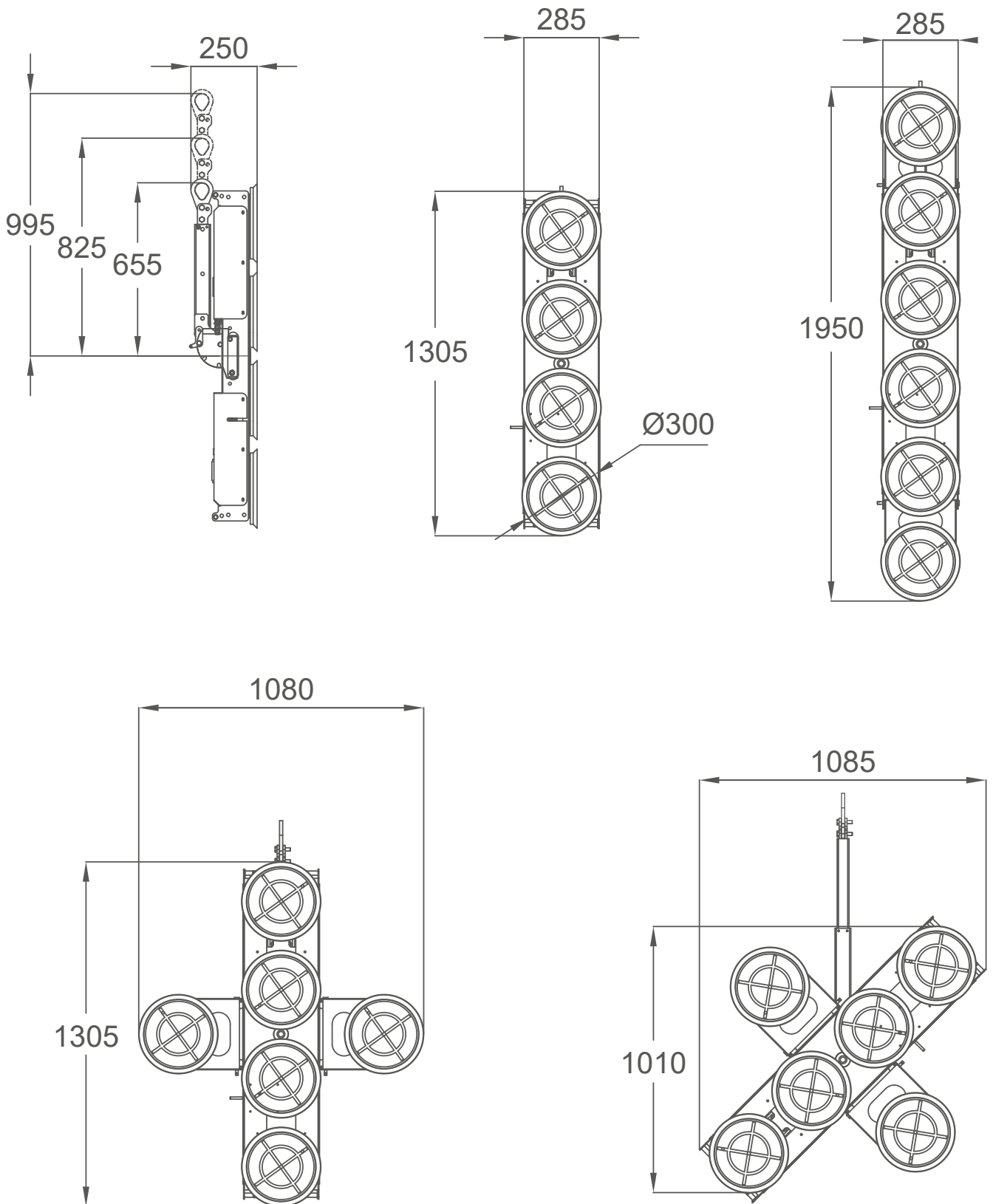



















































## OVERALL DIMENSIONS



## OVERALL INFORMATIONS

	<b>N°</b>	4	6
	<b>KG</b>	300	450
	<b>KG</b>	56	68

## SYMBOLS

	Weight		Engine		Boom Angle		Minipicker
	Counterweight		Diesel Fuel		Boom Length		Back Wheel Loading Point
	Crane		Petrol Fuel		Boom Radius		Front Wheel Loading Point
	Dimensions L x W x H		Tank		Jib on Board		Working Radius
	Stabilization Area		Power		Without Jib on Board		Stabilizing Bar
	Travel Speed		Battery		Jib Hook Radius		Standard
	Gradeability		Lithium Battery		Jib Length and Angle		Factory max. load
	Outrigger Load		Powerpack		Jib Length		Building site max. load
	Track Loading		Main Winch		Jib Radius		Maximum inclination of the machinery
	Outriggers Setup		Hookblock		Manipulator Length		Hydraulic oil
	Ext Tracks Width		Slewing		Manipulator Radius		Winter Warm-up Kit
	Chart on Tracks		Slewing Locked		Number of vacuum pads		Horizontal Boom Angle
	Slope		Outriggers mats		Grabber		White Pads for Steel Tracks

### REMARKS REFERRING TO LOAD CHART

- The load charts are calculated according to EN 13000.
- For the calculation of the load charts at least a wind speed of 9m/s (33km/h) and regarding the load a sail area of 1m<sup>2</sup> per ton load and a wind resistance coefficient of 1.2 on the load have been taken into account. For lifting of loads with large sail areas and/or high wind resistance coefficients the maximum wind speed as stated in the load charts has to be reduced.
- Lifting capacities are given in kilograms.
- The weight of the hook blocks and hooks is part of the load and therefore it must be deducted from the lifting capacities.
- Working radii are measured from the slewing centre.
- The lifting capacities given for the telescopic boom apply if the folding jib is removed.
- Subject to modification of lifting capacities.

**YOUR  
JEKKO  
DEALER**

**EN** All specifications and features herein described can be changed without prior advice. All indicated data are indicative only and are not binding as crane performs differently depending on its use. **IT** Tutte le caratteristiche e le specifiche descritte possono essere soggette a variazioni senza preavviso. Tutti i dati riportati sono forniti a puro titolo informativo e non sono impegnativi dal momento che le prestazioni della macchina variano in funzione dell'utilizzo. **DE** Unangekündigte Änderungen sämtlicher Eigenschaften und Daten sind möglich. Alle Angaben sind Richtwerte und nicht verbindlich da die Leistungen der Vorrichtung von deren Einsatz abhängen. **ES** Todas las características y las especificaciones aquí indicadas pueden ser sujetas a variaciones sin aviso. Se dan todos los datos aquí indicados como simples informaciones. No se consideran como vinculantes, dado que las prestaciones del maquinario pueden variar. **FR** Toutes les caractéristiques et le spécifications descriptives peut être sujet à variation sans préavis. Tout les données rapportés sont fourni à titre informatif et ne sont pas engager au moment que la prestation de la machine change en fonction de l'emploi.

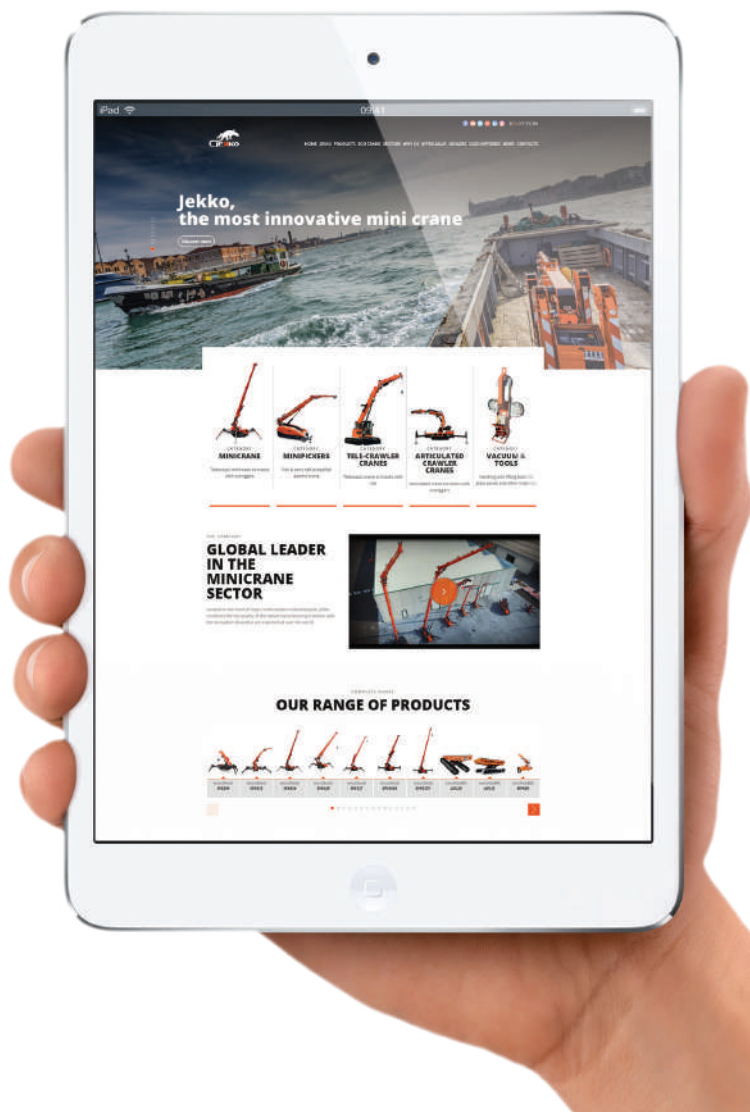

[www.jekko-cranes.com](http://www.jekko-cranes.com)

Visit [jekko-cranes.com](http://jekko-cranes.com) to keep in contact with us, discover all the latest news and find out technical details of all our products.



**Jekko s.r.l.**

Via Campardone, 1 - 31014 Colle Umberto (TV) - Italy  
info@jekko.it - www.jekko-cranes.com

SERIAL NUMBER:

21.03.2022 | Rev. 1